

# ***Kanlux***



Kanlux **SMART**

## **Kanlux SMART RELAYS**

# Kanlux

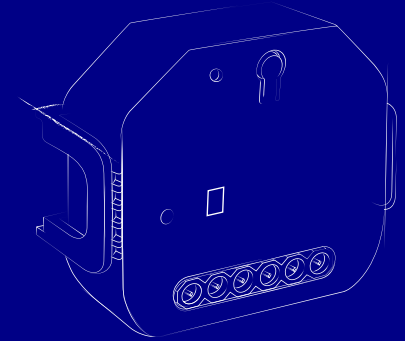
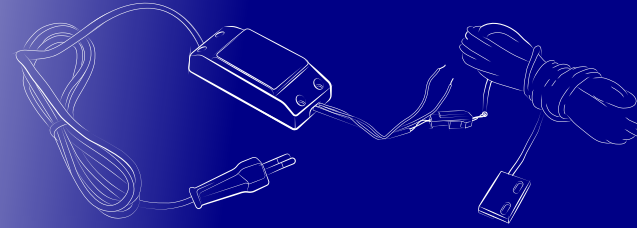

**Control Kanlux SMART products** using the **SMART LIFE** mobile application



You can control the home furnishings (window blinds, garage door) using your voice.

**Kanlux SMART relays work with Amazon Alexa and Google Home.**



# Kanlux

The **Kanlux SMART** set of relays communicates via a protocol **Wi-Fi 2.4GHz**

**34948**  
**S SWITCH ON/OFF**



**34949**  
**S SWITCH SHUTTER**



**34950**  
**S SWITCH G DOOR**





# Kanlux

## On / off relay

34948 S SWITCH ON/OFF

## for the SMART LIFE application

→ Flush mounted on / off relay (60mm boxes) or in a switchboard on a DIN rail (mounting bracket included) allows us to control the circuits of plug-in sockets or light switches, giving them the SMART function without the need for additional installation between them.

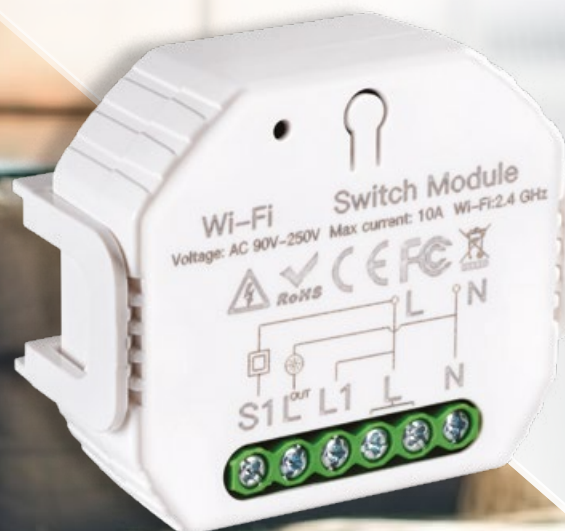

## How to install Relay on / off 34948 S SWITCH ON/OFF in the SMART LIFE application

1



Download the SMART LIFE app from the App Store or Google Play Store.  
Register a user account and log in to the application.

2



Connect the device to the network (the device should be connected to the electrical system by a person with appropriate qualifications).

Press „+“ in the upper right corner of the window.  
Select the „Electrical appliance“ category and then select the „BLE + Wi-Fi switch“ type.

Confirm the device is ready for the pairing process, the acoustic signal from the device is fast.

If the audible signal is slow, hold down the RESET button for 7 seconds.  
Make sure and confirm that the LED is flashing quickly (the beep repeats quickly). Then take the next step.

3



Select a Wi-Fi network and enter the password for the network.  
Remember that Kanlux SMART devices operate on the 2.4 GHz Wi-Fi band.

A countdown time and pairing steps will appear on the screen.  
Assign the device to a room at home and start using the Kanlux Smart ON / OFF relay from the app.

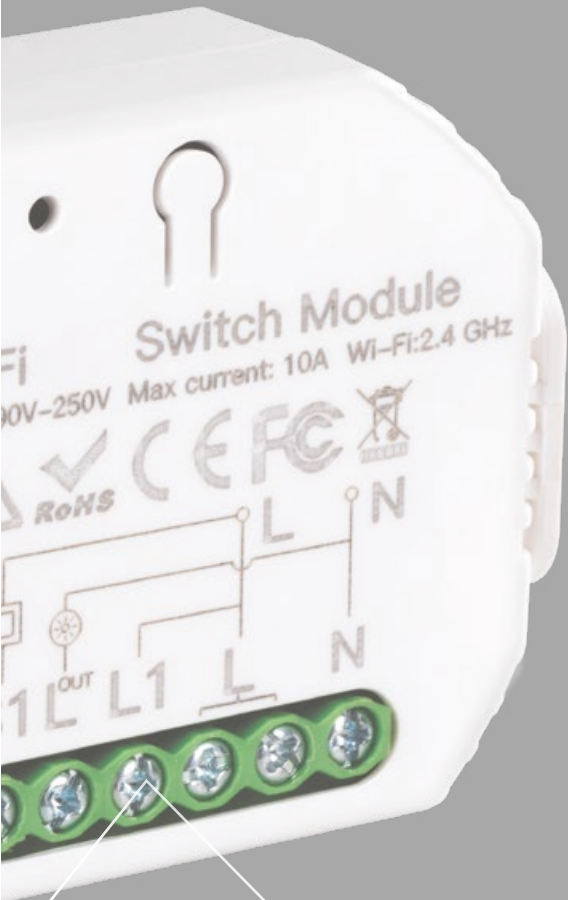



# Kanlux

## Relay for controlling roller shutters and blinds motors

34949 S SWITCH SHUTTER

### for SMART LIFE application

→ Relay for controlling the motors of roller shutters and shutters, mounted on a flush (60mm boxes) or in a switchgear on a DIN rail (mounting bracket included) allows us to control the roller shutters from the level of the application installed on the mobile device.



## How to add a Relay to control roller shutter and blind motors 34949 S SWITCH SHUTTER for SMART LIFE application

1



Download the SMART LIFE app from the App Store or Google Play Store.  
Register a user account and log in to the application.

2



Connect the device to the network (the device should be connected to the electrical system by a person with appropriate qualifications).

Press „+“ in the upper right corner of the window.  
Select the „Electrical appliance“ category and then select the „Curtain“ type switch BLE + Wi-Fi.

Confirm the device is ready for the pairing process, the acoustic signal from the device is fast.

If the audio signal is slow, hold down the RESET button for 7 seconds.  
Make sure and confirm that the LED is flashing quickly (the beep repeats quickly). Then take the next step.

3



Select a Wi-Fi network and enter the password for the network.  
Remember that Kanlux SMART devices operate on the 2.4 GHz Wi-Fi band.

A countdown time and pairing steps will appear on the screen.  
Match the device to a room at home and start using it from the Kanlux Smart roller shutter relay from the application.

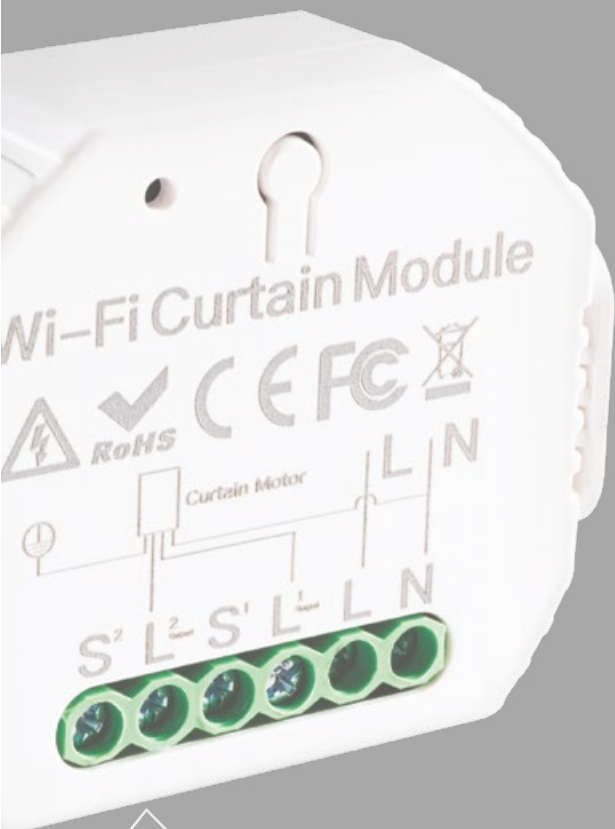



# Kanlux

## Relay for gate control 34950 S SWITCH G DOOR for the SMART LIFE application

→ Gate control relay with opening and closing sensor. It can cooperate in a smart environment with other dedicated or virtual buttons by assigned functions - such as close or open.





## How to add a relay to control the gate 34950 S SWITCH G DOOR for SMART LIFE application

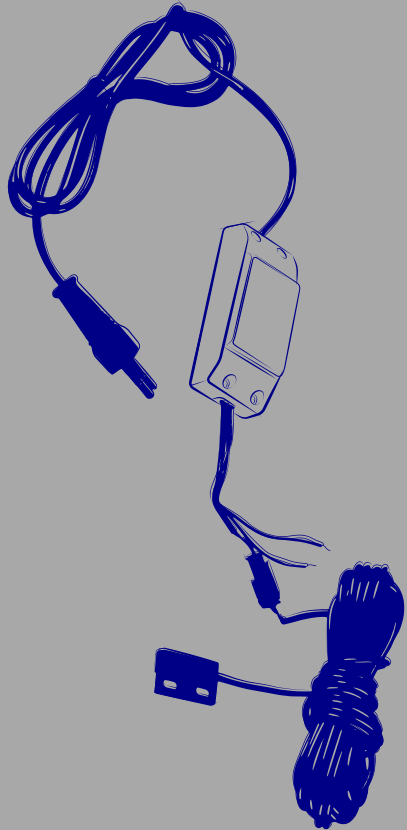

1



Download the SMART LIFE app from the App Store or Google Play Store.  
Register a user account and log in to the application.

2



Connect the device to the network.  
Press „+“ in the upper right corner of the window. Select the „Electrical Appliance“ category and then select the „Garage.“ Door Opener BLE + Wi-Fi “.

Confirm that the device is ready for the pairing process, LED on device flashes.

If the LED flashes slowly, hold down the RESET button for 7 seconds.  
Make sure and confirm that the LED is flashing fast  
Then take the next step.

3



Select a Wi-Fi network and enter the password for the network.  
Remember that Kanlux SMART devices operate on the 2.4 GHz Wi-Fi band.

A countdown time and pairing steps will appear on the screen. Assign the device to a room at home and start using the Kanlux Smart garage door relay from the application.

# Kanlux

## Parameters:

→ Power supply 220-240V~ 50Hz,

→ **Wi-Fi 2,4 GHz 16dBm**

→ **Bluetooth**

---

**34948** S SWITCH ON/OFF

---

**34949** S SWITCH SHUTTER

---

**34950** S SWITCH G DOOR

---

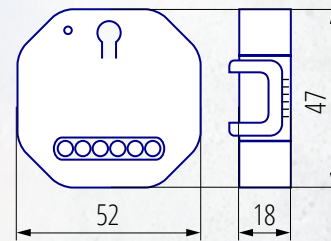

**34948**  
S SWITCH ON/OFF

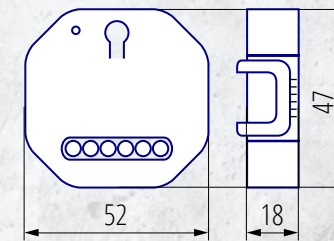

**34949**  
S SWITCH SHUTTER

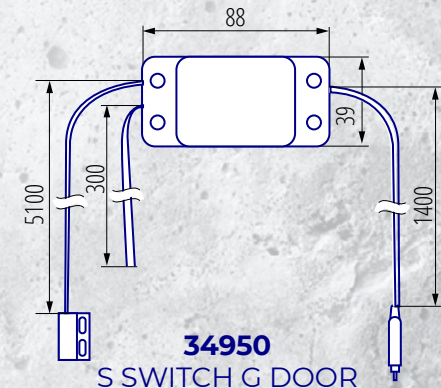

**34950**  
S SWITCH G DOOR

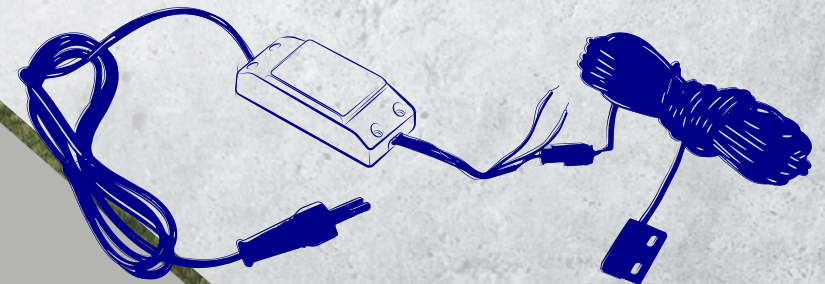



# Kanlux



Kanlux SMART



**well packed**

kanlux.com